

# Ampli550

Amplified Big Button Telephone



# CONTENTS

<b>Contents</b>	<b>1</b>
<b>Introduction</b>	<b>3</b>
Unpacking the Telephone	4
<b>Description</b>	<b>5</b>
General Description	5
Key Description	7
LCD Description	8
<b>Installation</b>	<b>10</b>
Night Light Function	10
Wall Mounting	10
<b>Settings</b>	<b>11</b>
Making a Call	11
Pause	12
Receiving a Call	12
Muting the Microphone	12
Using the Amplification Function	12
Using you Phone with hearing aids	13
Using Audio and Headset jacks	13
Hands-free	14
Hold Function	14
Ringer Setting	15
Speed Dial Setting	15
Flash Signal	18
Shaker	18
Caller ID	19
Phone Book	20
<b>Menu Functions</b>	<b>22</b>
Menu Navigation	22
Menu Map	22
Set Display	23
Set Phone	24
Setting Date & Time	26
Set Talk	27
<b>Caller ID On Call Waiting</b>	<b>29</b>

# CONTENTS

<b>Feature List</b>	<b>30</b>
<b>Troubleshooting</b>	<b>32</b>
<b>Safety Information</b>	<b>33</b>
<b>Regulatory Compliance</b>	<b>34</b>
<b>Guarantee</b>	<b>37</b>

# INTRODUCTION

Congratulations on purchasing your Geemarc Ampli550. This is a multifunction telephone which offers features such as hands free use, caller ID\*, caller announce, talking keypad, a phone book and quick dial. It offers amplification, helpful for those with hearing difficulties. It has a large button, easy to see and use keypad, to help stop any misdialing. This telephone is compatible with hearing aids.

It is important that you read the instructions below in order to use your Geemarc telephone to its full potential. Keep this user guide in a safe place for future reference.

This guide explains how to use the following telephone:

## Ampli550



\* To use the caller display facility, you must subscribe to your network provider's caller display service.

# INTRODUCTION

## Unpacking the Telephone

---

When unpacking the telephone, you should find the following in the box:

- Wall mount bracket
- 1 Ampli550 unit
- 1 Ampli550 handset with curly cord
- 2 Telephone line cords (one long and one short)
- 1 power adaptor
- 4 AAA rechargeable batteries
- User Guide

### IMPORTANT SAFETY INSTRUCTIONS

Read and understand the Installation Guide & User Manual.

When using your telephone equipment, basic safety precautions should always be followed to reduce the risk of fire, electric shock and injury to person, including the following.

**WARNING:** To avoid the possibility of electrical shock, do not use this product near water (For example, near a bathtub, wash basin, kitchen sink or laundry tub, in a wet basement or near a swimming pool);

**WARNING:** Avoid using the telephone during electrical storms. There may be a remote risk of electric shock from lightning. If the electrical storm is present in your immediate area, possibility of electrical shock exists;

**WARNING:** Do not use the phone if you suspect a gas leak in the area. The phone's electrical contacts could create a spark, which could ignite any heavy concentration of leaking gas.

## SonicAlert

Sonic Alert Warranty Center  
1081 West Innovation Dr.  
Kearney, MO 64060

Sales: 248-577-5400 Fax: 248-577-5433  
Customer Service & Warranty: 1-888-864-2446  
RMA@sonicalert.info



# DESCRIPTION

## General Description

---

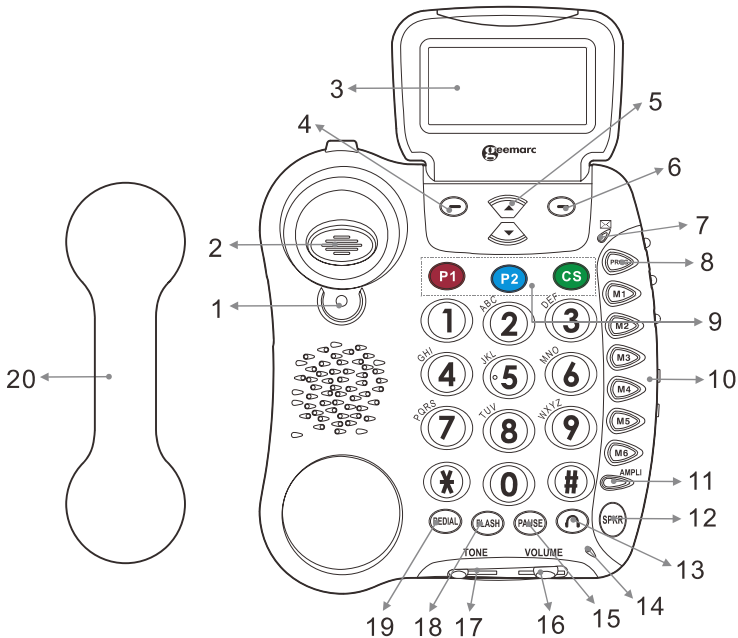

- |   |  |
|---|--|
| 1. Handset Hanger                             | 11. Amplifier key/indicator ( <b>AMPLI</b> ) |
| 2. Hook Switch                                | 12. Speaker Key ( <b>SPKR</b> )              |
| 3. Large LCD Screen                           | 13. Headset Key (📞)                          |
| 4. Left Soft Key                              | 14. Microphone                               |
| 5. Up/Down Scroll                             | 15. Pause Key                                |
| 6. Right Soft Key                             | 16. Volume adjustment                        |
| 7. Message waiting / new call LED             | 17. Tone adjustment                          |
| 8. Programming Key                            | 18. Flash Key                                |
| 9. Emergency Speed Dial ( <b>P1, P2, CS</b> ) | 19. Redial Key                               |
| 10. Speed Dial Keys ( <b>M1-M6</b> )          | 20. Handset                                  |



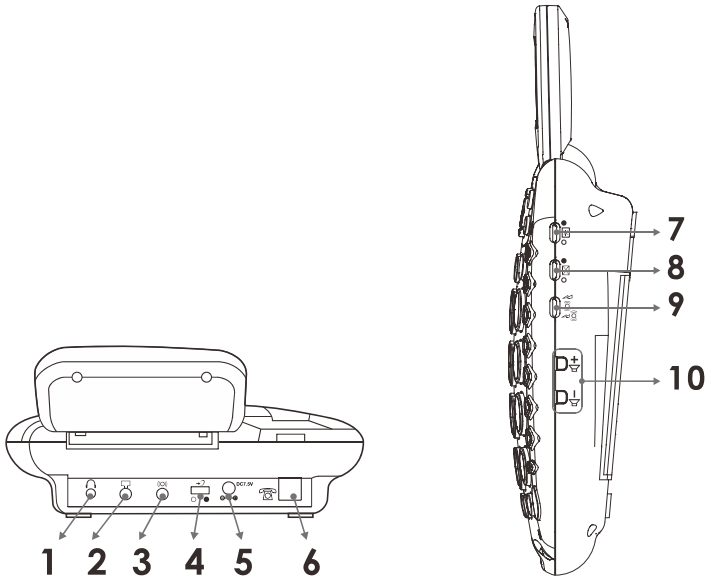





# DESCRIPTION

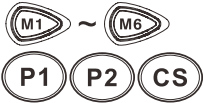

1. Headset jack 2.5mm
2. Audio neckloop jack 3.5mm
3. Optional Bed Shaker jack
4. Volume Reset Override Switch (ON/OFF)
5. Power jack
6. Phone Line Cord jack
7. Back Light Switch
8. New Call Indicator Switch
9. Ringer / shaker / strobe select mode
10. Volume controls for ringer and speakerphone

# DESCRIPTION

## Key Description

	Make/Answer/End a call. Activates the speakerphone if pressed during a call, as described in page 14.
	Last number redial, as described in page 11. Insert a pause when pre-dialing a number
	Highlight or scroll through the menu options. Enter the CID list, as described in page 23.
	Perform the functions indicated by the text immediately over it (on the bottom line of the display) which changes time by time.
	Press this button to turn the extra amplification ON or OFF.
	The nine keys are used as one-touch speed dial keys.
	This button is used to disconnect a call and re-establish dial tone or to switch over to another caller if you use custom calling services such as call waiting.
	Press this key to insert one or more pauses.
	Use them to adjust the volume of ringer, dialing talking and CID talking and speakerphone volume.
	To activate the headset mode.



# DESCRIPTION

## LCD Description

In standby mode, the large LCD display will show as below:

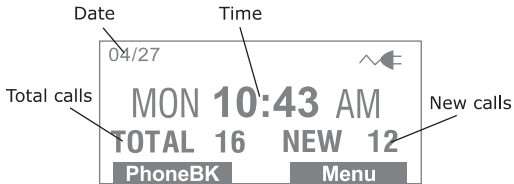

If you forget to connect the phone line cord, "**No line**" will show on the screen.

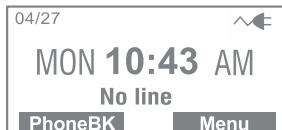

When you press the **Menu** soft key, the display will show the main menu. Use ▲ or ▼ key to scroll through the menu and select the desired one, then press **Select** soft key to confirm.



When a new call comes in, the screen will display the caller's phone number and/or name. If you subscribe to cid.



This shows you the total and new calls to be reviewed. In this example, you have 16 calls in total which includes 12 new calls.



# DESCRIPTION



If the caller has exercised the option to prevent their name and number from being sent, "**Blocked number**" will be shown on the display.

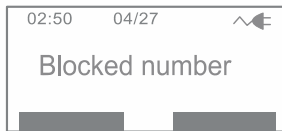

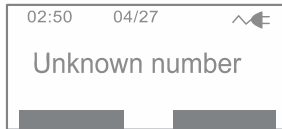

This message will display when someone calls from an area where the telephone company is not offering the caller identification services or is not yet providing number delivery to your area.



# INSTALLATION

## Night Light Function

---

If you move the **back light** switch (  ) located on the right side of the phone to  position, the LCD back light will always be bright so your phone can also be used as a night light.

## Wall Mounting

---

1. Slide the handset hanger tab out and reverse its position (rotate it 180 degrees). Slide it back into place so that the hook points up (see diagram 1). This will keep the handset from falling out of the cradle when it is mounted on the wall.
2. Install two self-tapping screws (not supplied) at a distance of 80 mm from each other and located on a vertical line.
3. Place the phone onto the screw-heads and slide down to secure (see diagram 2).

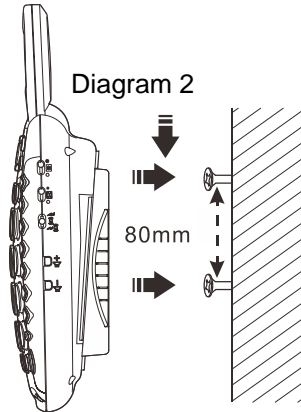
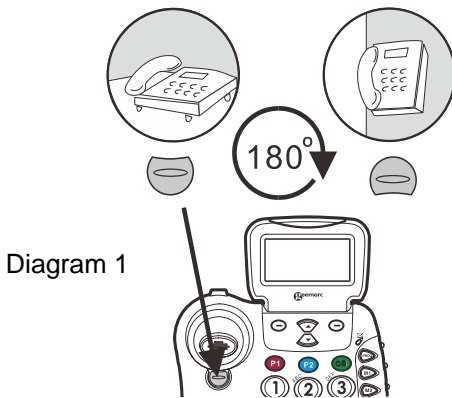

# SETTINGS

## Making a Call

---

1. To make a call, lift the handset, listen for a dial tone and adjust your volume & tone settings (see page 12).
2. You can dial a number manually or press one of the memory dial buttons. Please refer to page 16.
3. To end the call, replace the handset on the base.

You can enter the desired phone number in standby mode, which allows you to make corrections before dialing. Follow these steps:

1. Enter a telephone number (up to 32 digits). Check it. If you make a mistake while entering a number, press the **Clear** soft key to edit it.
2. When the number appears correctly, lift the handset or press the **SPKR** key.

## Last Number Redial

The **REDIAL** key is used to quickly redial the last number you dialed.

1. Lift the handset and listen for the dial tone.
2. Press the **REDIAL** key. The phone will redial up to 32 digits automatically.

## Dialing a Number from the Redial List

1. Press the **REDIAL** key in standby mode.
2. Press **▲** or **▼** key repeatedly until you find out the number you want to dial.
3. Pick up the handset or press the **SPKR** key to dial out the number.

## Clearing the Redial List

1. Press the **REDIAL** key in standby mode.
2. Press and hold the **0** key, then the LCD display will show **Empty list** to indicate you that the all the entries in redial list have been deleted.

# SETTINGS

## Pause

---

Pressing the **PAUSE** key will insert a 3 second pause in the dialing sequence. This is intended to be used with memory dialing.

## Receiving a Call

---

When a new call is received the phone will ring and the visual ring indicator will flash. If you have a voice message: **New voice mail** will be shown on the LCD.

1. To answer a call, lift the handset and speak.
2. Adjust your volume & tone settings if needed (see page 13).
3. To end the call, replace the handset on the base.

## Muting the Microphone

---

During a conversation, you can temporarily switch your phone's microphone off, so that the other party cannot hear you.

To mute your microphone, press the **Mute** soft key during the conversation. The "**Mute**" appears on the LCD.

To unmute your microphone, press the **Unmute** soft key. You will restore the normal condition.

## Using the Amplification Function

---

Your phone is equipped with a specialized amplification function designed to fit your needs. During a conversation you can adjust the controls on the front panel of the phone (see diagram 3) and use the **AMPLI** key. Adjust the **VOLUME** control and **TONE** control to fit the levels to your hearing requirements.

When you press the **AMPLI** key, the handset receiver volume adjustment is 15-40db. The **TONE** control allows you to either boost low or high frequency range. If you press the **AMPLI** key again, the receiver volume adjustment is 0-15db. The **TONE** control cannot be used.

# SETTINGS

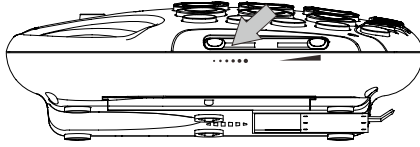





Diagram 3

**CAUTION:** This telephone can produce very high (loud) sound levels. Repeated incremental exposure to amplification levels greater than 18 dB may be harmful to people without hearing loss. Always adjust the volume control to the minimum setting after using the phone.

## Volume reset override switch

In standard mode the  switch is set to "○", and the phone will reset to normal sound levels when you hang up. This allows people who do not require the level of amplification offered on the phone to use it. If you would like to override the reset, simply turn the override switch  on the rear of the phone to "●".

**Important Note:** When the  switch is set to "●", you do not need to press the **AMPLI** key to turn on the amplification feature, the volume can be very loud and may damage your hearing. If the phone works with batteries but without power adapter, in the handset mode, the Amplify feature will not be activated even if "Amplify mode" appears on the LCD.

## Using your Phone with hearing aids

---

Your phone can be used with hearing aids equipped with a telecoil (T-coil). Adjust your hearing aid "T-switch" to the "T" position. Make sure to hold the handset close to your hearing aid.

## Using Audio and Headset Jacks

---

Your phone is equipped with both an Audio and Headset jack, providing total flexibility and multi-functionality. Both the jacks are amplified, allowing you to adjust both the tone and volume.

# SETTINGS

## Audio Neckloop Jack

Using this jack allows you to listen through your neckloop or headphones while speaking into the handset or speakerphone.

## Headset Jack

This jack can accommodate many hands-free headsets. Using this jack you can listen and speak through your hands-free headset.

## Hands-free



---

During a call, you may turn on the speakerphone built in the phone. In this mode you can enjoy the comfort of the handsfree conversation.

To turn the feature on, press the **SPKR** key during a call, then replace the handset on the base. The  icon appears on the LCD.

To turn the feature off, and keep on talking in normal mode, simply pick up the handset. The  icon will disappear.

## Adjusting Speaker Volume

In speaker mode you can adjust the speaker volume by using the Volume Controls  or  located on the right side of the phone.

## Hold Function

---

During a call, you can press the **Hold** soft key to put a call on hold and the LCD will display "**Call on hold**". Hanging up the handset will not disconnect the call.

To continue the conversation, simply pick up the handset or press the **Unhold** soft key.



# SETTINGS

## Ringer Setting

---

You can select your own base ringer tone and adjust the ringer volume. You can also adjust the volume to "**Ringer OFF**" in order to turn off the ringer.

1. Press **Menu** soft key to display the main menu list.
2. Press **▼** key to move to **Set Phone** and then press **Select** soft key.
3. Press **Select** soft key to choose **Set Ring**. Press **Select** soft key again to choose **Ringer volume**. You can choose from volume setting **1 through 5**. Every time you press the **▲** or **▼** key, the phone rings with the selected volume level.
4. Press the **Select** soft key to confirm.
5. Press **▼** key to set the **Ringer tone**, press the **Select** soft key.
6. Press the **▲** or **▼** key repeatedly to select the desired ringer tone. Each time you press the **▲** or **▼** key, the phone rings with the selected ringer tone.
7. Press **Select** soft key to confirm and return to the previous menu.

In standby mode You can also adjust the ringer volume by using the Volume Controls  or  on the right side of the base phone. The display will show the current level. For example: **volume 1**.

**WARNING:** RING VOLUME IS VERY LOUD AND CAN DAMAGE YOUR HEARING. NEVER PUT YOUR EAR CLOSE TO THE RINGER.

## Speed Dial Setting

---

### One-touch Memory

Your phone allows you to program 9 frequently dialed numbers: 6 speed dials and 2 priority speed dials (p1 and p2) and a customer service button (cs).. Each memory key can store up to 24 digits.



# SETTINGS

## Storing Memory Numbers

1. Use the keypad to enter the number you want to store. You can use the **Clear** soft key to edit the number.
2. Press and hold one of the Memory dial keys, then press the **Save** soft key. The display shows **Name:**.
3. Enter the name you want to use with the number. You can use the **Clear** soft key to edit it. Press the **Save** soft key to confirm.
4. Press the **▲** or **▼** key repeatedly to select the desired ringtone to use with the number.
5. Press **Select** soft key to confirm.

### Note:

Entering a new number in the same location will automatically erase the previous number.

## Viewing and Dialing Two Touch Memory Numbers

In standby mode press one of the memory dial keys or Speed dial keys, the display will show the corresponding number. Lift the handset or press the **SPKR** key to dial it out.

## Using the Options

1. In standby mode press one of the memory dial keys or Speed dial keys.
2. Press **Options** soft key to choose the desired option:
  - **Play Voice:** allows you to play the voice prompt of this entry. If you have recorded the name for this entry, the system will announce the name, otherwise it can only announce the number.
  - **Record Voice:** allows you to record the name for the selected entry.
  - **Erase Voice:** allows you to delete the name you have recorded for the selected entry.
  - **Edit:** allows you to edit the selected entry.
  - **Erase:** allows you to delete the selected entry.

# SETTINGS

## Note:

If you record a voice prompt for an entry, an icon  will appear before the name of this entry.

## Two-touch Memory

Your phone allows you to program 10 frequently two-touch memory numbers (0~9). Each memory key can store up to 24 digits.

## Storing Memory Numbers

1. Use the keypad to enter the number you want to store. You can use the **Clear** soft key to edit the number.
2. Press and hold the **PROG** key.
3. Press one of the numeric keys (0~9), then press the **Save** soft key. The display shows **Name:**.
4. Enter the name you want to use with the number. You can use the **Clear** soft key to edit it. Press the **Save** soft key to confirm.
5. Press the **▲** or **▼** key repeatedly to select the desired ring tone to use with the number.
6. Press **Select** soft key to confirm.

## Note:

Entering a new number in the same location will automatically erase the previous number.

## Viewing and Dialing Memory Numbers

In standby mode press and hold one of the numeric keys (0~9), the display will show the corresponding number. Lift the handset or press the **SPKR** key to dial it out.

## Using the Options

1. In standby mode press and hold one of the numeric keys (0~9).
2. Press **Options** soft key to choose the desired option:
  - **Play Voice:** allows you to play the voice prompt of this entry. If you have recorded the name for this entry, the

# SETTINGS

system will announce the name, otherwise it can only announce the number.

- **Record Voice:** allows you to record the name for the selected entry.
- **Erase Voice:** allows you to delete the name you have recorded for the selected entry.
- **Edit:** allows you to edit the selected entry.
- **Erase:** allows you to delete the selected entry.

## Note:

If you record a voice prompt for an entry, an icon  will appear before the name of this entry.

## Flash Signal

---

When the line is engaged, pressing the **FLASH** key sends the flash signal. This key is used in conjunction with special services (e.g. call waiting) which can be available in your phone network. For further details please contact your network telephone company.

To use the said special services, just press the **FLASH** key while the line is engaged.

## Note:

This key only operates when your telephone has been installed for Tone mode (**Dialing Mode** menu must be set to **Tone** option).

## Shaker

---

Your telephone incorporates several options to alert you that the phone is ringing. The loud, adjustable Ringer as well as the bright Strobe and optional Bed shaker or any combination of these allow you to customize the phone to fit your needs.

Your phone is equipped with a bright Strobe light, which flashes a very bright strobe when the phone rings. It's almost impossible to miss telephone calls when you select the Strobe Ringer. If you purchased the optional Bed shaker, simply plug into the shaker jack and place it between your mattress and box spring.

# SETTINGS

## Caller ID

---

This telephone automatically displays an incoming caller's number/name along with the date and time of the call. It will record up to 30 calls of up to 15 digits and store the data into memory.

**IMPORTANT:** You must subscribe to Caller ID Service from your local telephone company to utilize this feature.

## Viewing the Caller List

Use ▲ or ▼ key to scroll through entries. Records will be listed in the order they were received.

## Dialing a Number from the Caller List

Use ▲ or ▼ key to scroll to the desired number, if the number is 10 or 11 digits, you can add or remove a 1 from in front of the number. For example if the original number in Caller ID list was 800-965-9043, press the \* key repeatedly to change it to 1-800-965-9043 or 965-9043. Or if the number is 1-987-654-3210, press the \* key repeatedly to change it to 987-654-3210 or 654-3210. Then pick up the handset or press the **SPKR** key to dial it out.

## Using the Caller List Options

1. Use ▲ or ▼ key to locate the desired record.
2. Press **Options** soft key to choose the desired option:
  - **Erase:** allows you to delete the selected entry.
  - **Erase all:** allows you to delete all the entries.
  - **Store:** allows you to add the entry to the phonebook.

### Note:

If you select **Erase all**, a message "**Erase all?**" will ask you to confirm or not. Press **Yes** to confirm or **No** to cancel.

# SETTINGS

## Phone Book

---

The phonebook built in your phone allows you to store frequently used numbers so that you can easily make a call without having to remember or enter the phone number.

### Character Map

To enter a specific alphanumeric character, press one or more times the relevant key for the required character according to the following table: once for the first character, twice for the second and so on.

#### Key Characters in the displayed order

0	0				
1	(SpC)	_	*	,	1
2	Aa	Bb	Cc	(	2
3	Dd	Ee	Ff	)	3
4	Gg	Hh	Ii	#	4
5	Jj	Kk	Ll	/	5
6	Mm	Nn	Oo	'	6
7	Pp	Qq	Rr	Ss	7
8	Tt	Uu	Vv	?	8
9	Ww	Xx	Yy	Zz	9

#### Notes:

- If you want to shift the case between upper and lower, while entering letters, press the \* key.
- When entering the same letter twice or a different letter with the same key, wait for a few seconds for the cursor to move automatically and then select the next letter.

### Adding the Phonebook Entries

1. Enter a phone number (up to 24 digits) while in standby mode and then press **Save** soft key.
2. Press **Save** soft key again, the display shows "**Name:**". Enter the name you want to use, then press **Save** soft key to confirm.
3. Press the ▲ or ▼ key repeatedly to select the desired ringer tone to use with the number.
4. Press **Select** soft key to confirm.

# SETTINGS

## Notes:

If you make a mistake while entering a name or a number, use the **Clear** soft key to correct it. Each time you press this key, the last digit is deleted.

## Viewing the Phonebook Entries

1. Press the **PhoneBk** soft key in standby mode to enter the phonebook.
2. Press **▲** Or **▼** key repeatedly until the desired entry is displayed.
3. Lift the handset or press the **SPKR** key to dial out this number.

## Note:

If you have activated the Review Talking feature in advance, every time you press **▲** Or **▼** key, the system will announce the number of the highlighted entry.

## Using the Phonebook Options

1. Press **PhoneBk** soft key to enter the phonebook.
2. Press **▲** Or **▼** key repeatedly until the desired entry is highlighted.
3. Press **Options** soft key to choose the desired option:
  - **Play Voice:** allows you to play the voice prompt of this entry. If you have recorded the name for this entry, the system will announce the name, otherwise it will only announce the number.
  - **Record Voice:** allows you to record the name for the selected entry.
  - **Erase Voice:** allows you to delete the name you have recorded for the selected entry.
  - **Edit:** allows you to edit the selected entry.
  - **Erase:** allows you to delete the selected entry.

## Note:

If you record a voice prompt for an entry, an icon  will appear before the name of this entry.

# MENU FUNCTIONS

## Menu Navigation

---

### To access a menu option:

1. To display menu list, press the **Menu** soft key.
2. To scroll through menu options, press **▲** or **▼** key repeatedly.
3. To select a menu, press the **Select** soft key when the desired menu appears on the display.
4. Repeat if necessary.

### To exit from any menu:

If you press the **Back** soft key or the **Exit** soft key, the phone returns to the previous screen.

## Menu Map

---

### Set Display

Set Language (see page 24)

Set Contrast (see page 24)

Font Size (see page 25)

Hour Format (see page 25)

Date Format (see page 25)

### Set Phone

Set Ring (see page 15)

Call Waiting (see page 26)

Set Flash (see page 26)

Dialing Mode (see page 26)

AUTO ON HOOK (see page 27)

### Set Time/Date (see page 27)

### Set Talk

DIALING TALKING (see page 28)

CID TALKING (see page 28)

REVIEW TALKING (see page 28)

Voice Prompt (see page 29)

# MENU FUNCTIONS

## Set Display

---

Using this feature, you can customize the display settings, according to your requirements (language, contrast, smaller font and hour format).

### Language Setting

The phone supports up to 4 predefined languages: English, Spanish, French and German. You can change the language used to display the menu messages.

1. Press **Menu** soft key to display the main menu list.
2. Press **Select** soft key to access **Set Display**.
3. Press **Select** soft key to select **Set Language**.
4. Press **▲** or **▼** key repeatedly to scroll through the options. Each language will be displayed in its own native translation.
5. Press **Select** soft key to select the required language.

### LCD Contrast Setting

1. Press **Menu** soft key to display the main menu list.
2. Press **Select** soft key to access **Set Display**.
3. Press the **▼** key to move to **Set Contrast**, press **Select** soft key.
4. Press **▲** or **▼** key repeatedly to choose among the 8 available contrast levels and then press **Select** soft key.

### Switch to smaller font

1. Press **Menu** soft key to display the main menu list.
2. Press **Select** soft key to access **Set Display**.
3. Press **▲** or **▼** key repeatedly to move to **Dim:X--->x**, press **Select** soft key.
4. Press **▲** or **▼** key repeatedly to choose **ON** or **OFF** and then press **Select** soft key.

#### Note:

If you select **ON**, when you pre-dial a number, if the number exceeds 8 digits, the font will be switched to smaller size automatically.



# MENU FUNCTIONS

## Hour Format Setting

1. Press **Menu** soft key to display the main menu list.
2. Press **Select** soft key to access **Set Display**.
3. Press **▲** Or **▼** key repeatedly to move to **Hour Format**, press **Select** soft key.
4. Press **▲** Or **▼** key repeatedly to choose **12 hour clock** or **24 hour clock** and then press **Select** soft key.

### Note:

If you select **12 hour clock**, AM/PM will appear on the right of the time in standby mode.

## Date Format Setting

1. Press **Menu** soft key to display the main menu list.
2. Press **Select** soft key to access **Set Display**.
3. Press **▲** or **▼** key repeatedly to move to **Date Format**, press **Select** soft key.
4. Press **▲** or **▼** key repeatedly to choose **MM/DD** or **DD/MM** and then press **Select** soft key.

## Set Phone

---

### Keypad Tones Setting

1. Press **Menu** soft key to display the main menu list.
2. Press the **▼** key to move to **Set Phone** and then press **Select** soft key.
3. Press **Select** soft key to access **Set Ring**.
4. Press the **▲** or **▼** key to choose **Keypad Tones**, then press **Select** soft key.
5. You can use **▲** or **▼** key to choose **ON** or **OFF** to enable or disable the function.
6. Press the **Select** soft key.

### Call Waiting

1. Press **Menu** soft key to display the main menu list.

# MENU FUNCTIONS

2. Press the ▼ key to move to **Set Phone** and then press **Select** soft key.
3. Press the ▼ key to move to **Call Waiting** and then press **Select** soft key. The display shows the current setting.
4. Use ▲ or ▼ key to select **ON/OFF** to activate/deactivate the call waiting function, press **Select** soft key to confirm.

## Flash Time Setting

1. Press **Menu** soft key to display the main menu list.
2. Press the ▼ key to move to **Set Phone** and then press **Select** soft key.
3. Press ▲ or ▼ key repeatedly to move to **Set Flash** and then press **Select** soft key. The display shows the current setting.
4. Press ▲ or ▼ key repeatedly to choose among **100ms**, **300ms** and **600ms**, press **Select** soft key.

## Dialing Mode Setting

1. Press **Menu** soft key to display the main menu list.
2. Press the ▼ key to move to **Set Phone** and then press **Select** soft key.
3. Press ▲ or ▼ key repeatedly to move to **Dialing Mode** and then press **Select** soft key. The display shows the current setting.
4. Press ▲ or ▼ key repeatedly to choose between **Tone** and **Pulse**, press **Select** soft key.

### Notes:

- This menu is not used in countries where only Tone dialing is available.
- If you are not sure which dialing mode to select, please contact your local service provider.

## Auto on hook

When the Auto on hook feature is on, your phone will automatically disconnect the line after 15 seconds if the phone is

# MENU FUNCTIONS

left off the hook. This will restore your line to be able to receive another call even if you leave the handset off the base.

1. Press **Menu** soft key to display the main menu list.
2. Press the ▼ key to move to **Set Phone** and then press **Select** soft key.
3. Press ▲ or ▼ key repeatedly to move to **AUTO ON HOOK** and then press **Select** soft key. The display shows the current setting.
4. Use ▲ or ▼ key to choose **ON** or **OFF** to activate or deactivate the auto on hook feature.
5. Press the **Select** soft key to confirm.

## Setting Date & Time

---

In standby mode, the phone displays the current date and time to help you keep track of your appointments. You need to set the date and time so that when you receive calls they will appear with the correct date and time.

1. Press **Menu** soft key to display the main menu list.
2. Press ▲ or ▼ key repeatedly to move to **Set Time /Date**, press **Select** soft key. The current settings are displayed.
3. Enter the current time using the numeric keypad, press **Save** soft key.
4. Enter the current date using the numeric keypad, press **Save** soft key.
5. Enter the current year using the numeric keypad, press **Save** soft key.

### Note:

You can select the hour format and date format. Please refer to par. **Hour Format Setting** and **Date Format Setting**.

# MENU FUNCTIONS

## Set Talk

---

### Dialing Talking

This feature allows you to check the number you have entered in standby mode without looking at the display.

1. Press **Menu** soft key to display the main menu list.
2. Press **▲** or **▼** key repeatedly to move to **Set Talk**, press **Select** soft key.
3. Press **Select** soft key to access **DIALING TALKING**.
4. Use **▲** or **▼** key to select **ON/OFF** to activate/deactivate the dialing talking function, press **Select** soft key to confirm.

### CID Talking

The talking CID can announce the number that comes in unless the caller blocks the number, so this feature allows you to check the caller ID number or caller's name when a new call is being received without looking at the display. Note that if you have stored a number in phone book and recorded the corresponding name, when an incoming call with this number comes in, the system will announce the name associates with this number.

1. Press **Menu** soft key to display the main menu list.
2. Press **▲** or **▼** key repeatedly to move to **Set Talk**, press **Select** soft key.
3. Press the **▼** key to move to **CID TALKING**, press **Select** soft key.
4. Use **▲** or **▼** key to select **ON/OFF** to activate / deactivate the CID talking function, press **Select** soft key to confirm.

### Review Talking



The system can announce the number that stored in phone book when you are reviewing the phone book, so the feature allows you to check these numbers when you use **▲** or **▼** key to scroll through the phone book entries. Note that if you have recorded the corresponding name, the system will announce the name

# MENU FUNCTIONS

associates with this number. To activate this feature, do the following steps:

1. Press **Menu** soft key to display the main menu list.
2. Press **▲** or **▼** key repeatedly to move to **Set Talk**, press **Select** soft key.
3. Press **▲** or **▼** key repeatedly to move to **REVIEW TALKING**, press **Select** soft key.
4. Use **▲** or **▼** key to select **ON/OFF** to activate / deactivate the CID talking function, press **Select** soft key to confirm.

## Note:

You can use  and  button to adjust the talking volume, and at the same time, the memo announcement volume will be adjusted accordingly.

## Voice Prompt

You are able to select the language used to play the voice prompt messages.

1. Press **Menu** soft key to display the main menu list.
2. Press **▲** or **▼** key repeatedly to move to **Set Talk**, press **Select** soft key.
3. Press **▲** or **▼** key repeatedly to move to **Voice Prompt**, press **Select** soft key.
4. Use **▲** or **▼** key to scroll through the options. Each language will be displayed in its own native translation.
5. Press the **Select** soft key to choose the required language.

# CALLER ID ON CALL WAITING

When you subscribe to Call Waiting service from your local telephone company and activate the Call Waiting function via menu, the telephone will display the name and number of the second caller while you are having a conversation.

Caller ID info displayed

Caller 1  
436-1234

Caller two's information is displayed

Caller 1  
4  
Caller 2  
291-5678

1. When you are on the line, the telephone will automatically display the name and number of the second caller.
2. Press the **FLASH** key to answer the second caller.
3. When you have finished, press the **FLASH** key to continue with your conversation with the first caller.

# FEATURE LIST

- FSK and DTMF dual system Caller ID
- Extra Large Caller ID Screen
- Caller ID list with up to 30 entries
- Caller ID/Call Waiting
- Phonebook with up to 39 entries
- Amplification function
- Amplified Headset jack
- Hearing Aid compatible
- Adjustable volume control
- Adjustable extra-loud ringer
- Big Keypad buttons
- 3.5mm Bed Shaker jack
- Real time clock with date & time
- Flash, Mute, Hold
- 9 one-touch speed dial buttons
- 10 two-touch speed dial buttons (0~9)
- LCD contrast setting
- Hour format setting
- Date format setting
- Dialing talking, CID talking & Reviewing talking
- Hands-free speakerphone
- Auto on-hook
- Dialing mode selection
- Wall mounting

# FEATURE LIST





# TROUBLESHOOTING

## **No dial tone**

- Check that all phone cord connections are securely plugged into the telephone & wall jack.
- Check that the phone is in the correct dialing mode, tone or pulse.
- Plug another phone into the wall jack to make sure your phone service is working properly.

## **No audible ringer**

- Make sure the ringer is not turned off.
- Check the volume level of the ringer.
- You may have too many extensions on your line. Try unplugging a few devices.

## **No amplification**

- Check to see if the Amplify key is "On". The red light should be lit. Also check power supply connections.

## **Noise, Static, Interference while using the handset**

- A filter may be required for homes with a DSL line or near Radio towers.

## **Caller ID information does not show**

- Make sure you are subscribed to Caller ID through your local company.

# SAFETY INFORMATION

## **General**

Only use the power supply included with the product.

Do not open the unit. Contact the helpline for all repairs.

The phone is capable of amplifying sounds to a loud volume. It is important to instruct all potential users of its proper operation. It is advised to adjust the volume control to its minimum level (Low) when not in use and alert other users that hearing damage can potentially result from misuse.

## **Cleaning**

Clean the telephone with a soft cloth. Never use polishes or cleaning agents - they could damage the finish or the electrics inside.

## **Environmental**

Do not expose to direct sunlight.

Always ensure there is a free flow of air over the surfaces of the telephone.

Do not place any part of your product in water and do not use it in damp or humid conditions e.g. bathrooms.

Do not expose your product to fire or other hazardous conditions.

Unplug your phone from the telephone socket during thunderstorms because it could damage your telephone. Your guarantee does not cover thunderstorm damage.

The telephone is designed for working within a temperature range of 5°C to 45°C.

# REGULATORY COMPLIANCE

- This equipment complies with Part 68 of the FCC rules and the requirements adopted by the ACTA. On the bottom of this equipment is a label that contains, among other information, a product identifier in the format US: AAAEQ##TXXXX. If requested, this number must be provided to the telephone company.
- All applicable certification jacks Universal Service Order Codes (USOC) for the equipment is provided (i.e. RJ11C) in the package with each piece of approved terminal equipment.
- A plug and jack used to connect this equipment to the premises wiring and telephone network must comply with the applicable FCC Part 68 rules and requirement adopted by the ACTA. A compliant telephone cord and modular plug is provided with this product. It is designed to be connected to a compatible modular jack that is also compliant. See installation instructions for details.
- The REN is useful to determine the quantity of devices you may connect to your telephone line and still have all of those devices ring when your telephone number is called. In most, but not all areas, the sum of the REN's of all devices connected to one line should not exceed five (5.0). To be certain of the number of devices you may connect to your line, as determined by the REN, you should contact your local telephone company to determine the maximum REN for your calling area.
- If this equipment causes harm to the telephone network, the telephone company will notify you in advance that temporary discontinuance of service may be required. But if advance notice isn't practical, the telephone company will notify the customer as soon as possible. Also, you will be advised of your rights to file a complaint with the FCC if you believe it is necessary.
- The telephone company may make changes in its facilities, equipment, operation or procedures that could affect the operation of the equipment. If this happens the telephone company will provide advance notice in order for you to make necessary modifications to maintain uninterrupted service.
- This equipment may not be used on coin service provided by the telephone company. Connection to party lines is subject to state tariffs. This equipment is hearing aid compatible.

# REGULATORY COMPLIANCE

**Warning:** Changes or modifications to this unit not expressly approved by the party responsible for compliance could void the user's authority to operate the equipment.

**NOTE:** This equipment has been tested and found to comply with the limits for a Class B digital device, pursuant to Part 15 of the FCC Rules. These limits are designed to provide reasonable protection against harmful interference in a residential installation. Some cordless telephones operate at frequencies that may cause interference to nearby TV's and VCR's; to minimize or prevent such interference, the base of the cordless telephone should not be placed near or on top of a TV or VCR; and, if interference is experienced, moving the cordless telephone farther away from the TV or VCR will often reduce or eliminate the interference. However, there is no guarantee that interference will not occur in a particular installation. If this equipment does cause harmful interference to radio or television reception, which can be determined by turning the equipment off and on, the user is encouraged to try to correct the interference by one or more of the following measures:

- Re-orient or relocate the receiving antenna.
- Increase the separation between the equipment and receiver.
- Connect the equipment into an outlet on a circuit different from that to which the receiver is connected.
- Consult the dealer or an experienced radio TV technician for help.
  - If trouble is experienced with this equipment, for repair or warranty information, please contact our customer service staff at: 1-888-864-2446 (RMA@sonicalert.info)
  - If the equipment is causing harm to the telephone network, the telephone company may request that you disconnect the equipment until the problem is resolved.
  - Please follow instructions for repairing if any; otherwise do not alter or repair any part of device except as specified.

**Opening the equipment or any attempt to perform repairs will**

# REGULATORY COMPLIANCE

## GUARANTEE

- Connection to party line service is subject to state tariffs. Contact the state public utility commission, public service commission or corporation for information.
- If your home has specially wired alarm equipment connected to the telephone line, ensure the installation of this telephone equipment does not disable your alarm equipment. If you have questions about what will disable alarm equipment, consult your telephone company or a qualified installer.
- This equipment is hearing aid compatible.

Sonic Alert warrants the phone against any defect in materials or

# GUARANTEE

workmanship for the period of one (Does not include batteries) year from the date of purchase.

Should you experience a problem, contact our customer service department

Be sure to save your sales receipt as proof of purchase date should you need warranty service.

Within a period of one year from purchase date, Sonic Alert will repair or replace (our discretion) your phone at no cost, if a defect in materials or workmanship is found. If we elect to replace your phone, we may replace it with a new or reconditioned product of the same or similar design.

Repair or replacement will be warranted for a period of 90 days or the original time on the original warranty, whichever is longer.

The warranty does not cover accidents, negligence or breakage to any parts or damage due to installing incorrect batteries. This includes shipping damage, failure to follow instructions, misuse, fire, floods, use of incompatible accessories, Acts of God or failure in your phone service carrier's line service. The product must not be tampered with or taken apart by anyone who is not an authorized

Sonic Alert representative. Tampering with the phone will void any written or implied warranties

Sonic Alert shall not be responsible for loss of time, inconvenience, property damage caused by your phone or any other accidental or consequential damages

Warranty service is available only with proof of purchase.

Simply send the Ampli550 (postpaid) and a copy of your sales slip

as proof of purchase to:

CS Green Customer Service key at top has been pre-programmed with our USA customer service number. Press the CS key to direct dial for any Customer Service or technical related help or questions. Our customer service department is available from 9Am-5Pm Monday through Friday Central time.

**Sonic Alert Warranty Center 1081 West Innovation Dr.  
Kearney, MO 64060 (RMA@sonicalert.info)**

**IMPORTANT: YOUR RECEIPT IS PART OF YOUR WARRANTY  
AND MUST BE RETAINED AND PRODUCED IN THE EVENT  
OF A WARRANTY CLAIM**

**SonicAlert**

Sonic Alert Warranty Center  
1081 West Innovation Dr.  
Kearney, MO 64060

Sales: 248-577-5400 Fax: 248-577-5433  
Customer Service & Warranty: 1-888-864-2446  
RMA@sonicalert.info

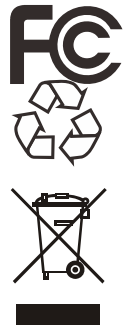

UGAmpli550\_US\_En\_v1.4